



**UniFi**<sup>®</sup> AC **SHD**

802.11ac Wave 2 Access Point  
with Dedicated Security Radio

Model: UAP-AC-SHD

QUICK START GUIDE

## Introduction

Thank you for purchasing the Ubiquiti Networks® UniFi® 802.11ac Wave 2 Access Point with Dedicated Security Radio. This Quick Start Guide is designed to guide you through installation and includes warranty terms.

**IMPORTANT:** The UAP-AC-SHD requires the UniFi Controller v5.4 or higher, available at: [www.ubnt.com/download/unifi](http://www.ubnt.com/download/unifi)

## Package Contents



UniFi AP AC SHD



Mounting Plate



Ceiling Backing Plate



Ceiling Screws (Qty. 4)



Keps Nuts (Qty. 4)



T-Bar Mounts (Qty. 2)



T-Bar Screws (Qty. 2)



Allen Wrench



Wall Screw (Qty. 4)



Screw Anchors (Qty. 4)



Release Tool



Cable Feed Plug



Quick Start Guide

**TERMS OF USE:** Ubiquiti radio devices must be professionally installed. Shielded Ethernet cable and earth grounding must be used as conditions of product warranty. TOUGH Cable™ is designed for outdoor installations. It is the professional installer's responsibility to follow local country regulations, including operation within legal frequency channels, output power, and Dynamic Frequency Selection (DFS) requirements.

## Installation Requirements

- Phillips screwdriver
- Drill and drill bit (8 mm for wall mounting or 3 mm for ceiling tile mounting)
- Optional: Drywall or keyhole saw (to cut 18 mm hole for Ethernet cable feed)
- Cat5/6 UTP cable for indoor installations

## Outdoor Installation Requirements

 **IMPORTANT:** The UAP-AC-SHD may be installed outdoors under an eave or other protected location. Do not install the UniFi AP in an open environment.

- Mounting location should be at least 60 cm (2 ft) from the edge of the eave or ceiling.
- Cable feed opening must be directed away from the open environment.
- Cable feed must be pointed downwards when wall-mounted.
- Shielded Category 5 (or above) cabling should be used for all outdoor wired Ethernet connections and should be grounded through the AC ground of the PoE.

We recommend that you protect your networks from harmful outdoor environments and destructive ESD events with industrial-grade, shielded Ethernet cable from Ubiquiti Networks. For more details, visit: [www.ubnt.com/toughcable](http://www.ubnt.com/toughcable)

## System Requirements

- Linux, Mac OS X, or Microsoft Windows 7/8/10
- Java Runtime Environment 1.6 (1.8 or newer recommended)
- Web Browser: Google Chrome (Other browsers may have limited functionality.)
- UniFi Controller software v5.4 or newer (available at: [www.ubnt.com/download/unifi](http://www.ubnt.com/download/unifi))

## Network Topology Requirements

- A DHCP-enabled network (for the AP to obtain an IP address as well as for the wireless clients after deployment)
- A UniFi Cloud Key or management station running the UniFi Controller v5.4 (or newer) software, located either on-site and connected to the same Layer 2 network, or off-site in the cloud or NOC

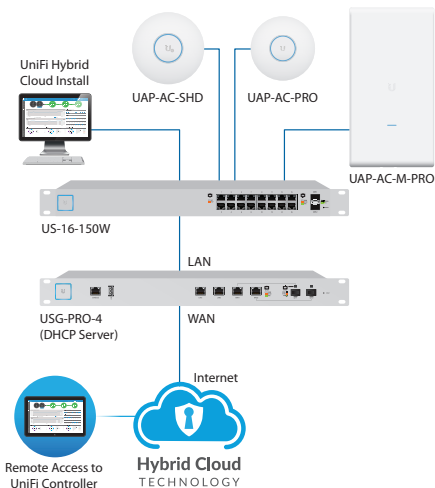

*Sample Network Diagram*

All UniFi devices support off-site management controllers. For setup details, see the User Guide on the website: [www.ubnt.com/download/unifi](http://www.ubnt.com/download/unifi)

## Hardware Overview

### LED



LED Color	Status
White	Factory default, waiting to be integrated.
Flashing White	Initializing.
Alternating White/Blue	Device is busy; do not touch or unplug it. This usually indicates that a process such as a firmware upgrade is taking place.
Blue	Indicates the device has been successfully integrated into a network and is working properly.
Quickly Flashing Blue	This is used to locate an AP. When you click <b>Locate</b> in the UniFi Controller software, the AP will flash. It will also display the location of the AP on the map.
Steady Blue with Occasional Flashing	Indicates the device is in an isolated state (all WLANs are brought down until an uplink is found).

## Ports

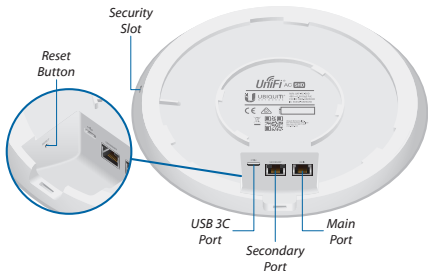

**Reset** The *Reset* button serves two functions for the UniFi AP:

- **Restart** Press and release the *Reset* button quickly.
- **Restore to Factory Default Settings** Press and hold the *Reset* button for more than five seconds.

**USB 3C** The *USB 3C* port is reserved for future use.

**Secondary** The *Secondary* port is a Gigabit Ethernet port used for bridging.

**Main** The *Main* port is a Gigabit Ethernet port used to connect the power and should be connected to the LAN and DHCP server.

**!** **IMPORTANT:** The UAP-AC-SHD cannot be powered by the US-8 or US-8-60W; however, it can be powered by other UniFi PoE Switches that provide 802.3at PoE+ power.

**📄** **Note:** If you need to remove the UniFi AP from the *Mounting Plate*, insert the included *Release Tool* in the *Security Slot* to release the *Lock Tab* and turn the UniFi AP counterclockwise.

## Mounting Plate

The *Mounting Plate* offers a variety of mounting holes for different applications. The legend printed on the *Mounting Plate* identifies the holes used for each application.

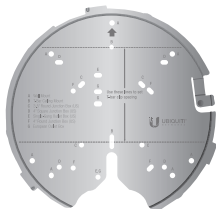

## Upgrade from UAP-AC-PRO

The UAP-AC-SHD is compatible with the UAP-AC-PRO mounting hardware, so you only need to remove the UAP-AC-PRO and replace it with the UAP-AC-SHD. To begin the upgrade:

1. Insert the *Release Tool* into the UAP-AC-PRO *Security Slot* to disengage the lock. Then turn the UAP-AC-PRO counterclockwise and lift it off of the mounting bracket.

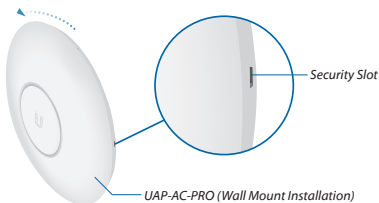

2. Unplug the Ethernet cable from the *Main* port.
3. Go to the *Connecting Ethernet* section.

## Hardware Installation

The UniFi AP can be mounted on a wall, ceiling tile, drop ceiling T-rail (up to 40 mm), or electrical junction box. Perform the steps for the appropriate installation.

 **Note for UniFi AP replacement:** The holes marked "A" on the *Mounting Plate* line up with the holes of mounting brackets used for previous UniFi AP models.

### Wall Mount

1. Position the *Mounting Plate* at the desired location on the wall with the *Arrow* pointing up.
2. Mark the four mounting holes labeled "A", and use an 8 mm drill bit to drill the holes. If your Ethernet cable feeds through the wall, cut or drill a hole approximately 18 mm in diameter. Then feed the CAT5/6 cable through the hole.

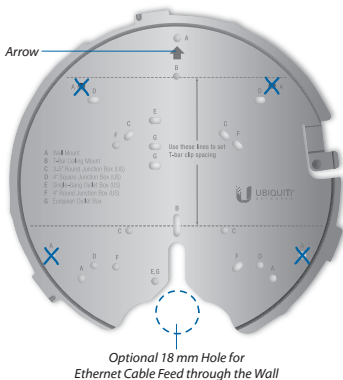

640-00279-06



3. Insert the *Screw Anchors* into the holes. Secure the *Mounting Plate* to the wall by inserting the *Wall Screws* into the anchors.

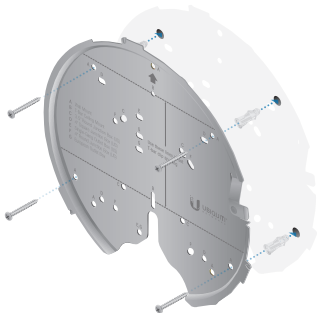

4. Go to the *Connecting Ethernet* section, and then return to step 5.
5. Align the *Arrow* on the top edge of the UniFi AP with the *Arrow* on the *Mounting Plate*.

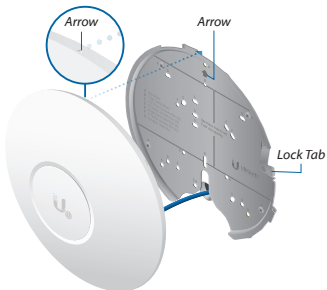

6. Rotate the UniFi AP clockwise until the tabs lock into place and the *Lock Tab* engages.



## Ceiling Mount

1. Remove the ceiling tile.
2. Place the *Ceiling Backing Plate* in the center of the ceiling tile. Mark the four mounting screw holes and an 18 mm hole for the Ethernet cable feed.

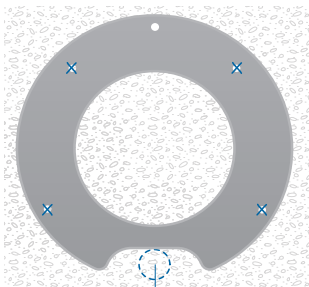

*Optional 18 mm Hole for Ethernet Cable Feed through the Ceiling Tile*

3. Use a 3 mm drill bit to drill the screw holes, and cut or drill the 18 mm hole for the Ethernet cable feed.
4. Insert the *Ceiling Screws* through the *Mounting Plate*, ceiling tile, and *Ceiling Backing Plate*. Fasten the screws using the *Keps Nuts*. Then feed the Ethernet cable through the tile and bracket.

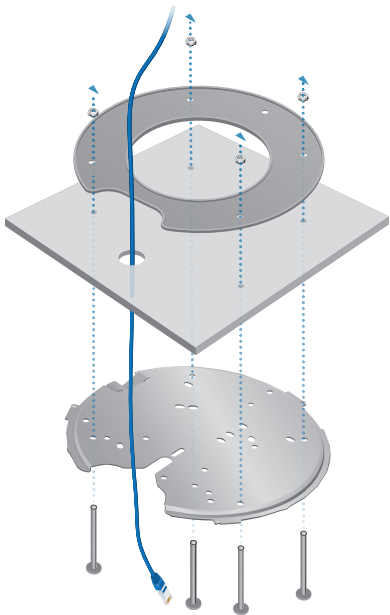

5. Perform the steps in the *Connecting Ethernet* section, and then return to step 6.
6. Align the *Arrow* on the top edge of the UniFi AP with the *Arrow* on the *Mounting Plate*.

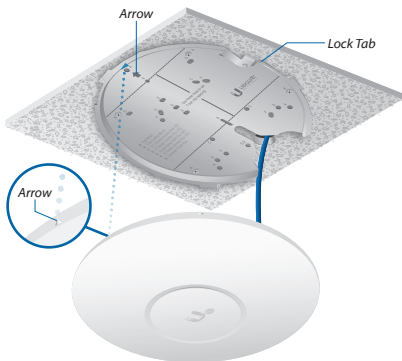

7. Rotate the UniFi AP clockwise until the tabs lock into place and the *Lock Tab* engages.



8. Set the ceiling tile back into place.

## T-Bar Mount

1. Remove the ceiling tiles on both sides of the T-bar you will use for mounting.
2. Loosen the set screws of the *T-Bar Mount*.



3. Insert the T-bar into a *T-Bar Mount*, and turn the *T-Bar Mount* clockwise to attach it. Use the included *Allen Wrench* to tighten the two set screws to secure the *T-Bar Mount*.

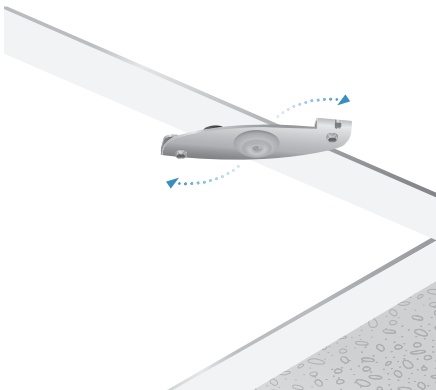

4. Attach the second *T-Bar Mount* but do not tighten the set screws.

5. Use the two dashed lines on the *Mounting Plate* to space the *T-Bar Mounts* 77 mm (3") apart.

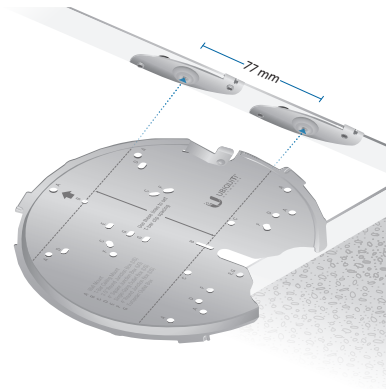

6. Tighten the two set screws on the second *T-Bar Mount*.



7. Insert the included *T-Bar Screws* into the holes marked "B" on the *Mounting Plate*, and then secure the plate to the *T-Bar Mounts*.

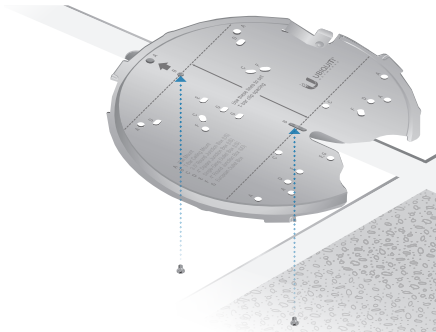

8. Drop the Ethernet cable between the plate and T-bar.

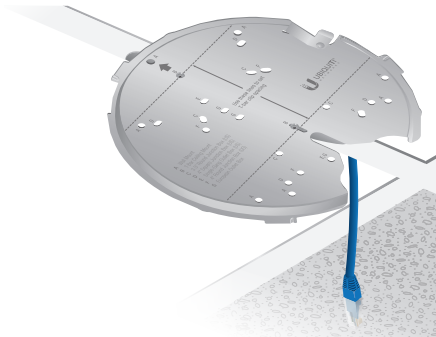

9. Perform the steps in the *Connecting Ethernet* section, and then return to step 10.
10. Align the *Arrow* on the top edge of the UniFi AP with the *Arrow* on the *Mounting Plate*.

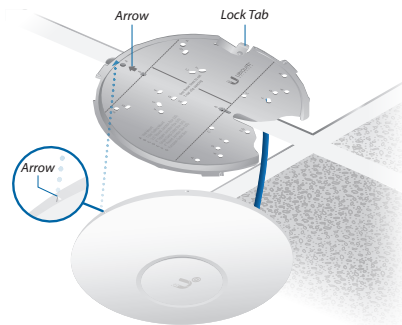

11. Rotate the UniFi AP clockwise until the tabs lock into place and the *Lock Tab* engages.



12. Set the ceiling tiles back into place.



## Junction or Outlet Box Mount

1. Use the legend printed on the *Mounting Plate* to select the appropriate mounting holes for your installation.
2. Pull the Ethernet cable through the *Mounting Plate*, and attach the *Mounting Plate* to the junction or outlet box using at least two screws (not included).



**Note:** For in-wall applications, position the *Mounting Plate* with the *Arrow* pointing upwards.

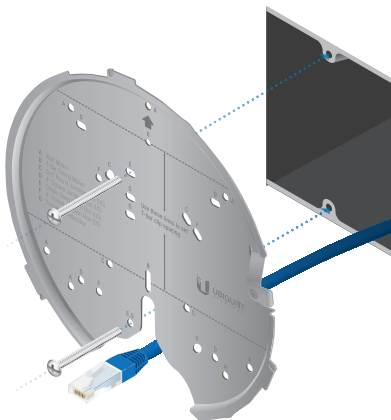

3. Perform the steps in the *Connecting Ethernet* section, and then return to step 4.

4. Align the *Arrow* on the top edge of the UniFi AP with the *Arrow* on the *Mounting Plate*.

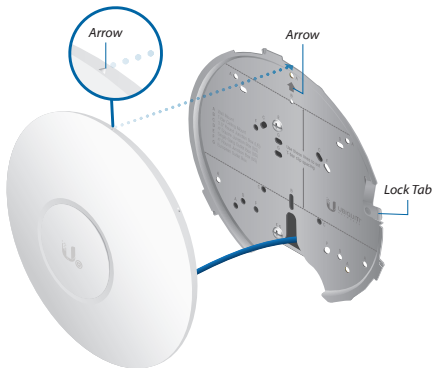

5. Rotate the UniFi AP clockwise until the tabs lock into place and the *Lock Tab* engages.



## Connecting Ethernet

1. Remove the rubber port cover from the UniFi AP.
2. If the Ethernet cable runs along the mounting surface, skip to step 3. If the Ethernet cable is fed through the wall or ceiling, insert the *Cable Feed Plug*.



3. Feed the Ethernet cable through the port cover.



**Note:** The feed hole will stretch to accommodate the RJ45 connector, and then seal around the cable.

4. Connect the Ethernet cable to the *Main* port and replace the port cover. Return to the appropriate instructions.

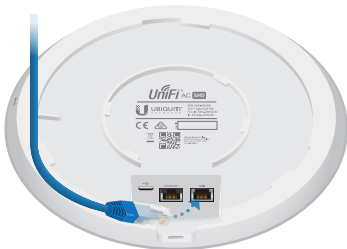

## Powering the UniFi AP

The UAP-AC-SHD features auto-sensing 802.3at PoE+ support and can be powered by any 802.3at PoE+ compliant switch.

### Connecting to a PoE+ Switch

Connect the Ethernet cable from the UniFi AP directly to a PoE+ port on the switch.

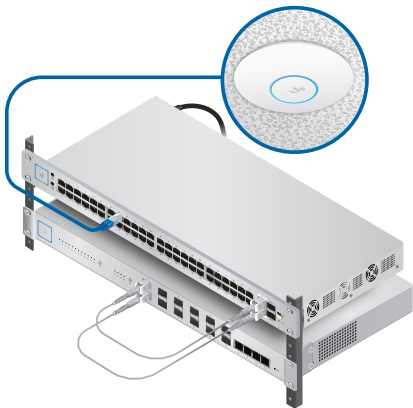

**!** **IMPORTANT:** The UAP-AC-SHD cannot be powered by the US-8 or US-8-60W; however, it can be powered by other UniFi PoE Switches that provide 802.3at PoE+ power.

## Software Installation

Download and install the latest version of the UniFi Controller software. Launch it and follow the on-screen instructions. The software and step-by-step instructions in the User Guide are available at: [www.ubnt.com/download/unifi](http://www.ubnt.com/download/unifi)

After you have installed the software and run the UniFi Installation Wizard, a login screen will appear for the UniFi Controller management interface. Enter the Admin Name and Password that you created and click **Log In**.

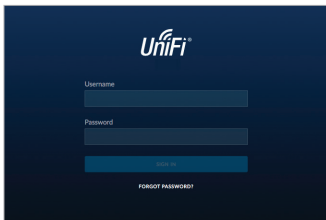

You can manage your wireless network and view network statistics using the UniFi Controller management interface. For information on configuring and using the UniFi Controller software, refer to the User Guide.

## Mobile App Installation

Ubiquiti Networks also offers the UniFi mobile app, which is available from the App Store (iOS) or Google Play™ Store (Android). You can use it to provision a UniFi AP for basic functionality without configuring a UniFi Controller. It also allows seamless provisioning of APs for remote controllers (controllers not on the same Layer 2 network) and easy access to local controllers and those monitored on [unifi.ubnt.com](http://unifi.ubnt.com)

## Specifications

UAP-AC-SHD	
Dimensions	220 x 220 x 48.1 mm (8.66 x 8.66 x 1.89")
Weight	700 g (1.54 lb)
with Mounting Kit	830 g (1.83 lb)
Networking Interface	(2) 10/100/1000 Ethernet Ports
Buttons	Reset
Power Method	PoE+ 802.3at
Power Supply	UniFi Switch (PoE)
Max. Power Consumption	20W
Max. TX Power	
2.4 GHz	25 dBm
5 GHz	25 dBm
Antennas	
2.4 GHz	(2) Dual-Polarity
5 GHz	(2) Dual-Polarity
Antenna Gain	
2.4 GHz	8 dBi
5 GHz	8 dBi
Wi-Fi Standards	802.11 a/b/g/n/ac/ac-wave2
Wireless Security	WEP, WPA-PSK, WPA-Enterprise (WPA/WPA2, TKIP/AES)
Mounting	Wall/Ceiling/Junction Box (Kits Included)
Operating Temperature	-10 to 70° C (14 to 158° F)
Operating Humidity	5 to 95% Noncondensing
Certifications	CE, FCC, IC

## Safety Notices

1. Read, follow, and keep these instructions.
2. Heed all warnings.
3. Only use attachments/accessories specified by the manufacturer.



**WARNING:** Do not use this product in a location that can be submerged by water.



**WARNING:** Avoid using this product during an electrical storm. There may be a remote risk of electric shock from lightning.

## Electrical Safety Information

1. Compliance is required with respect to voltage, frequency, and current requirements indicated on the manufacturer's label. Connection to a different power source than those specified may result in improper operation, damage to the equipment or pose a fire hazard if the limitations are not followed.
2. There are no operator serviceable parts inside this equipment. Service should be provided only by a qualified service technician.

## Limited Warranty

UBIQUITI NETWORKS, Inc (“UBIQUITI NETWORKS”) warrants that the product(s) furnished hereunder (the “Product(s)”) shall be free from defects in material and workmanship for a period of one (1) year from the date of shipment by UBIQUITI NETWORKS under normal use and operation. UBIQUITI NETWORKS’ sole and exclusive obligation and liability under the foregoing warranty shall be for UBIQUITI NETWORKS, at its discretion, to repair or replace any Product that fails to conform to the above warranty during the above warranty period. The expense of removal and reinstallation of any Product is not included in this warranty. The warranty period of any repaired or replaced Product shall not extend beyond its original term.

## Warranty Conditions

The above warranty does not apply if the Product:

- (I) has been modified and/or altered, or an addition made thereto, except by Ubiquiti Networks, or Ubiquiti Networks’ authorized representatives, or as approved by Ubiquiti Networks in writing;
- (II) has been painted, rebranded or physically modified in any way;
- (III) has been damaged due to errors or defects in cabling;
- (IV) has been subjected to misuse, abuse, negligence, abnormal physical, electromagnetic or electrical stress, including lightning strikes, or accident;
- (V) has been damaged or impaired as a result of using third party firmware;
- (VI) has no original Ubiquiti MAC label, or is missing any other original Ubiquiti label(s); or
- (VII) has not been received by Ubiquiti within 30 days of issuance of the RMA.

In addition, the above warranty shall apply only if: the product has been properly installed and used at all times in accordance, and in all material respects, with the applicable Product documentation; all Ethernet cabling runs use CAT5 (or above), and for outdoor installations, shielded Ethernet cabling is used, and for indoor installations, indoor cabling requirements are followed.

## Returns

No Products will be accepted for replacement or repair without obtaining a Return Materials Authorization (RMA) number from UBIQUITI NETWORKS during the warranty period, and the Products being received at UBIQUITI NETWORKS’ facility freight prepaid in accordance with the RMA process of UBIQUITI NETWORKS. Products returned without an RMA number will not be processed and will be returned freight collect or subject to disposal. Information on the RMA process and obtaining an RMA number can be found at: [www.ubnt.com/support/warranty](http://www.ubnt.com/support/warranty)



## Disclaimer

EXCEPT FOR ANY EXPRESS WARRANTIES PROVIDED HEREIN, UBIQUITI NETWORKS, ITS AFFILIATES, AND ITS AND THEIR THIRD PARTY DATA, SERVICE, SOFTWARE AND HARDWARE PROVIDERS HEREBY DISCLAIM AND MAKE NO OTHER REPRESENTATION OR WARRANTY OF ANY KIND, EXPRESS, IMPLIED OR STATUTORY, INCLUDING, BUT NOT LIMITED TO, REPRESENTATIONS, GUARANTEES, OR WARRANTIES OF MERCHANTABILITY, ACCURACY, QUALITY OF SERVICE OR RESULTS, AVAILABILITY, SATISFACTORY QUALITY, LACK OF VIRUSES, QUIET ENJOYMENT, FITNESS FOR A PARTICULAR PURPOSE AND NON-INFRINGEMENT AND ANY WARRANTIES ARISING FROM ANY COURSE OF DEALING, USAGE OR TRADE PRACTICE IN CONNECTION WITH SUCH PRODUCTS AND SERVICES. BUYER ACKNOWLEDGES THAT NEITHER UBIQUITI NETWORKS NOR ITS THIRD PARTY PROVIDERS CONTROL BUYER'S EQUIPMENT OR THE TRANSFER OF DATA OVER COMMUNICATIONS FACILITIES, INCLUDING THE INTERNET, AND THAT THE PRODUCTS AND SERVICES MAY BE SUBJECT TO LIMITATIONS, INTERRUPTIONS, DELAYS, CANCELLATIONS AND OTHER PROBLEMS INHERENT IN THE USE OF COMMUNICATIONS FACILITIES. UBIQUITI NETWORKS, ITS AFFILIATES AND ITS AND THEIR THIRD PARTY PROVIDERS ARE NOT RESPONSIBLE FOR ANY INTERRUPTIONS, DELAYS, CANCELLATIONS, DELIVERY FAILURES, DATA LOSS, CONTENT CORRUPTION, PACKET LOSS, OR OTHER DAMAGE RESULTING FROM ANY OF THE FOREGOING. In addition, UBIQUITI NETWORKS does not warrant that the operation of the Products will be error-free or that operation will be uninterrupted. In no event shall UBIQUITI NETWORKS be responsible for damages or claims of any nature or description relating to system performance, including coverage, buyer's selection of products (including the Products) for buyer's application and/or failure of products (including the Products) to meet government or regulatory requirements.

## Limitation of Liability

EXCEPT TO THE EXTENT PROHIBITED BY LOCAL LAW, IN NO EVENT WILL UBIQUITI OR ITS SUBSIDIARIES, AFFILIATES OR SUPPLIERS BE LIABLE FOR DIRECT, SPECIAL, INCIDENTAL, CONSEQUENTIAL OR OTHER DAMAGES (INCLUDING LOST PROFIT, LOST DATA, OR DOWNTIME COSTS), ARISING OUT OF THE USE, INABILITY TO USE, OR THE RESULTS OF USE OF THE PRODUCT, WHETHER BASED IN WARRANTY, CONTRACT, TORT OR OTHER LEGAL THEORY, AND WHETHER OR NOT ADVISED OF THE POSSIBILITY OF SUCH DAMAGES.

## Note

Some countries, states and provinces do not allow exclusions of implied warranties or conditions, so the above exclusion may not apply to you. You may have other rights that vary from country to country, state to state, or province to province. Some countries, states and provinces do not allow the exclusion or limitation of liability for incidental or consequential damages, so the above limitation may not apply to you. EXCEPT TO THE EXTENT ALLOWED BY LOCAL LAW, THESE WARRANTY TERMS DO NOT EXCLUDE, RESTRICT OR MODIFY, AND ARE IN ADDITION TO, THE MANDATORY STATUTORY RIGHTS APPLICABLE TO THE LICENSE OF ANY SOFTWARE (EMBEDDED IN THE PRODUCT) TO YOU. The United Nations Convention on Contracts for the International Sale of Goods shall not apply to any transactions regarding the sale of the Products.

## Compliance

### FCC

Changes or modifications not expressly approved by the party responsible for compliance could void the user's authority to operate the equipment.

This device complies with Part 15 of the FCC Rules. Operation is subject to the following two conditions.

1. This device may not cause harmful interference, and
2. This device must accept any interference received, including interference that may cause undesired operation.

This equipment has been tested and found to comply with the limits for a Class A digital device, pursuant to part 15 of the FCC Rules. These limits are designed to provide reasonable protection against harmful interference when the equipment is operated in a commercial environment. This equipment generates, uses, and can radiate radio frequency energy and, if not installed and used in accordance with the instruction manual, may cause harmful interference to radio communications. Operations of this equipment in a residential area is likely to cause harmful interference in which case the user will be required to correct the interference at his own expense.

This radio transmitter (FCC: SWX-UAPACSHD) has been approved by FCC.

## ISED Canada

### CAN ICES-3(A)/NMB-3(A)

This device complies with ISED Canada licence-exempt RSS standard(s). Operation is subject to the following two conditions:

1. This device may not cause interference, and
2. This device must accept any interference, including interference that may cause undesired operation of the device.

This radio transmitter (IC: 6545A-UAPACSHD) has been approved by ISED Canada.

The device for operation in the band 5150-5250 MHz is only for indoor use to reduce the potential for harmful interference to co-channel mobile satellite systems.

### CAN ICES-3(A)/NMB-3(A)

Le présent appareil est conforme aux CNR d'ISDE Canada applicables aux appareils radio exempts de licence. L'exploitation est autorisée aux deux conditions suivantes :

1. l'appareil ne doit pas produire de brouillage;
2. l'appareil doit accepter tout brouillage radioélectrique subi, même si le brouillage est susceptible d'en compromettre le fonctionnement.

Le présent émetteur radio (IC: 6545A-UAPACSHD) a été approuvé par ISDE Canada.

Les dispositifs fonctionnant dans la bande 5150-5250 MHz sont réservés uniquement pour une utilisation à l'intérieur afin de réduire les risques de brouillage préjudiciable aux systèmes de satellites mobiles utilisant les mêmes canaux.

## RF Exposure Warning

The antennas used for this transmitter must be installed to provide a separation distance of at least 29 cm from all persons and must not be located or operating in conjunction with any other antenna or transmitter, except as listed for this product's certification.

Les antennes utilisées pour cet émetteur doit être installé pour fournir une distance de séparation d'au moins 29 cm de toutes les personnes et ne doit pas être situé ou opérant en conjonction avec une autre antenne ou un autre émetteur, sauf dans les cas énumérés à la certification de ce produit.

## Australia and New Zealand



Warning: This is a Class A product. In a domestic environment this product may cause radio interference in which case the user may be required to take adequate measures.

## CE Marking

CE marking on this product represents the product is in compliance with all directives that are applicable to it.



## RoHS/WEEE Compliance Statement



### English

European Directive 2012/19/EU requires that the equipment bearing this symbol on the product and/or its packaging must not be disposed of with unsorted municipal waste. The symbol indicates that this product should be disposed of separately from regular household waste streams. It is your responsibility to dispose of this and other electric and electronic equipment via designated collection facilities appointed by the government or local authorities. Correct disposal and recycling will help prevent potential negative consequences to the environment and human health. For more detailed information about the disposal of your old equipment, please contact your local authorities, waste disposal service, or the shop where you purchased the product.

### Deutsch

Die Europäische Richtlinie 2012/19/EU verlangt, dass technische Ausrüstung, die direkt am Gerät und/oder an der Verpackung mit diesem Symbol versehen ist, nicht zusammen mit unsortiertem Gemeindeabfall entsorgt werden darf. Das Symbol weist darauf hin, dass das Produkt von regulärem Haushaltsmüll getrennt entsorgt werden sollte. Es liegt in Ihrer Verantwortung, dieses Gerät und andere elektrische und elektronische Geräte über die dafür zuständigen und von der Regierung oder örtlichen Behörden dazu bestimmten Sammelstellen zu entsorgen. Ordnungsgemäßes Entsorgen und Recyceln trägt dazu bei, potentielle negative Folgen für Umwelt und die menschliche Gesundheit zu vermeiden. Wenn Sie weitere Informationen zur Entsorgung Ihrer Altgeräte benötigen, wenden Sie sich bitte an die örtlichen Behörden oder städtischen Entsorgungsdienste oder an den Händler, bei dem Sie das Produkt erworben haben.

## Español

La Directiva 2012/19/UE exige que los equipos que lleven este símbolo en el propio aparato y/o en su embalaje no deben eliminarse junto con otros residuos urbanos no seleccionados. El símbolo indica que el producto en cuestión debe separarse de los residuos domésticos convencionales con vistas a su eliminación. Es responsabilidad suya desechar este y cualesquiera otros aparatos eléctricos y electrónicos a través de los puntos de recogida que ponen a su disposición el gobierno y las autoridades locales. Al desechar y reciclar correctamente estos aparatos estará contribuyendo a evitar posibles consecuencias negativas para el medio ambiente y la salud de las personas. Si desea obtener información más detallada sobre la eliminación segura de su aparato usado, consulte a las autoridades locales, al servicio de recogida y eliminación de residuos de su zona o pregunte en la tienda donde adquirió el producto.

## Français

La directive européenne 2012/19/UE exige que l'équipement sur lequel est apposé ce symbole sur le produit et/ou son emballage ne soit pas jeté avec les autres ordures ménagères. Ce symbole indique que le produit doit être éliminé dans un circuit distinct de celui pour les déchets des ménages. Il est de votre responsabilité de jeter ce matériel ainsi que tout autre matériel électrique ou électronique par les moyens de collecte indiqués par le gouvernement et les pouvoirs publics des collectivités territoriales. L'élimination et le recyclage en bonne et due forme ont pour but de lutter contre l'impact néfaste potentiel de ce type de produits sur l'environnement et la santé publique. Pour plus d'informations sur le mode d'élimination de votre ancien équipement, veuillez prendre contact avec les pouvoirs publics locaux, le service de traitement des déchets, ou l'endroit où vous avez acheté le produit.

## Italiano

La direttiva europea 2012/19/UE richiede che le apparecchiature contrassegnate con questo simbolo sul prodotto e/o sull'imballaggio non siano smaltite insieme ai rifiuti urbani non differenziati. Il simbolo indica che questo prodotto non deve essere smaltito insieme ai normali rifiuti domestici. È responsabilità del proprietario smaltire sia questi prodotti sia le altre apparecchiature elettriche ed elettroniche mediante le specifiche strutture di raccolta indicate dal governo o dagli enti pubblici locali. Il corretto smaltimento ed il riciclaggio aiuteranno a prevenire conseguenze potenzialmente negative per l'ambiente e per la salute dell'essere umano. Per ricevere informazioni più dettagliate circa lo smaltimento delle vecchie apparecchiature in Vostro possesso, Vi invitiamo a contattare gli enti pubblici di competenza, il servizio di smaltimento rifiuti o il negozio nel quale avete acquistato il prodotto.

# Declaration of Conformity

**български [Bulgarian]** С настоящото UBIQUITI NETWORKS декларира, че този тип радиосъоръжение UAP-AC-SHD е в съответствие с Директива 2014/53/ЕС. Цялостният текст на ЕС декларацията за съответствие може да се намери на следния интернет адрес: **[www.ubnt.com/compliance](http://www.ubnt.com/compliance)**

**Hrvatski [Croatian]** UBIQUITI NETWORKS ovime izjavljuje da je radijska oprema tipa UAP-AC-SHD u skladu s Direktivom 2014/53/EU. Cjeloviti tekst EU izjave o sukladnosti dostupan je na sljedećoj internetskoj adresi: **[www.ubnt.com/compliance](http://www.ubnt.com/compliance)**

**Čeština [Czech]** Tímto UBIQUITI NETWORKS prohlašuje, že typ rádiového zařízení UAP-AC-SHD je v souladu se směrnicí 2014/53/EU. Úplné znění EU prohlášení o shodě je k dispozici na této internetové adrese: **[www.ubnt.com/compliance](http://www.ubnt.com/compliance)**

**Dansk [Danish]** Hermed erklærer UBIQUITI NETWORKS, at radioudstyrstypen UAP-AC-SHD er i overensstemmelse med direktiv 2014/53/EU. EU-overensstemmelseserklæringens fulde tekst kan findes på følgende internetadresse: **[www.ubnt.com/compliance](http://www.ubnt.com/compliance)**

**Nederlands [Dutch]** Hierbij verklaar ik, UBIQUITI NETWORKS, dat het type radioapparatuur UAP-AC-SHD conform is met Richtlijn 2014/53/EU. De volledige tekst van de EU-conformiteitsverklaring kan worden geraadpleegd op het volgende internetadres: **[www.ubnt.com/compliance](http://www.ubnt.com/compliance)**

**English** Hereby, UBIQUITI NETWORKS declares that the radio equipment type UAP-AC-SHD is in compliance with Directive 2014/53/EU. The full text of the EU declaration of conformity is available at the following internet address: **[www.ubnt.com/compliance](http://www.ubnt.com/compliance)**

**Eesti keel [Estonian]** Käesolevaga deklareerib UBIQUITI NETWORKS, et käesolev raadioseadme tüüp UAP-AC-SHD vastab direktiivi 2014/53/EL nõuetele. ELi vastavusdeklaratsiooni täielik tekst on kättesaadav järgmisel internetiaadressil: **[www.ubnt.com/compliance](http://www.ubnt.com/compliance)**

**Suomi [Finnish]** UBIQUITI NETWORKS vakuuttaa, että radiolaitetyypin UAP-AC-SHD on direktiivin 2014/53/EU mukainen. EU-vaatimustenmukaisuusvakuutuksen täysimittainen teksti on saatavilla seuraavassa internetosoitteessa: **[www.ubnt.com/compliance](http://www.ubnt.com/compliance)**

**Français [French]** Le soussigné, UBIQUITI NETWORKS, déclare que l'équipement radioélectrique du type UAP-AC-SHD est conforme à la directive 2014/53/UE. Le texte complet de la déclaration UE de conformité est disponible à l'adresse internet suivante: **[www.ubnt.com/compliance](http://www.ubnt.com/compliance)**

**Deutsch [German]** Hiermit erkläre UBIQUITI NETWORKS, dass der Funkanlagentyp UAP-AC-SHD der Richtlinie 2014/53/EU entspricht. Der vollständige Text der EU-Konformitätserklärung ist unter der folgenden Internetadresse verfügbar: **[www.ubnt.com/compliance](http://www.ubnt.com/compliance)**

**Ελληνικά [Greek]** Με την παρούσα ο/η UBIQUITI NETWORKS, δηλώνει ότι ο ραδιοεξοπλισμός UAP-AC-SHD πληροί την οδηγία 2014/53/ΕΕ. Το πλήρες κείμενο της δήλωσης συμμόρφωσης ΕΕ διατίθεται στην ακόλουθη ιστοσελίδα στο διαδίκτυο: **[www.ubnt.com/compliance](http://www.ubnt.com/compliance)**

**Magyar [Hungarian]** UBIQUITI NETWORKS igazolja, hogy a UAP-AC-SHD típusú rádióberendezés megfelel a 2014/53/EU irányelvnek. Az EU-megfelelőségi nyilatkozat teljes szövege elérhető a következő internetes címen: **[www.ubnt.com/compliance](http://www.ubnt.com/compliance)**

**Íslenska [Icelandic]** Hér með lýsir UBIQUITI NETWORKS yfir því að UAP-AC-SHD er í samræmi við grunnkröfur og aðrar kröfur, sem gerðar eru í tilskipun 2014/53/EU. Fullur texti ESB samræmisýfirlýsing er að finna á eftirfarandi netfangi: **[www.ubnt.com/compliance](http://www.ubnt.com/compliance)**

**Italiano [Italian]** Il fabbricante, UBIQUITI NETWORKS, dichiara che il tipo di apparecchiatura radio UAP-AC-SHD è conforme alla direttiva 2014/53/UE. Il testo completo della dichiarazione di conformità UE è disponibile al seguente indirizzo Internet: **[www.ubnt.com/compliance](http://www.ubnt.com/compliance)**

**Latvīq kalba [Latvian]** Ar šo UBIQUITI NETWORKS deklarē, ka radioiekārta UAP-AC-SHD atbilst Direktīvai 2014/53/ES. Pilns ES atbilstības deklarācijas teksts ir pieejams šādā interneta vietnē: **[www.ubnt.com/compliance](http://www.ubnt.com/compliance)**

**Lietuvių kalba [Lithuanian]** Aš, UBIQUITI NETWORKS, patvirtinu, kad radijo įrenginių tipas UAP-AC-SHD atitinka Direktyvą 2014/53/ES. Visas ES atitikties deklaracijos tekstas prieinamas šiuo interneto adresu: [www.ubnt.com/compliance](http://www.ubnt.com/compliance)

**Malti [Maltese]** B'dan, UBIQUITI NETWORKS, niddikjara li dan it-tip ta' tagħmir tar-radju UAP-AC-SHD huwa konformi mad-Direttiva 2014/53/UE. Id-dikjarazzjoni tal-konformità tista' tiġi kkonsultata minn [www.ubnt.com/compliance](http://www.ubnt.com/compliance)

**Norsk [Norwegian]** UBIQUITI NETWORKS erklærer herved at utstyret UAP-AC-SHD er i samsvar med de grunnleggende krav og øvrige relevante krav i direktiv 2014/53/EU. Den fulle teksten til EU-samsvarserklæringen er tilgjengelig på følgende internettadresse: [www.ubnt.com/compliance](http://www.ubnt.com/compliance)

**Polski [Polish]** UBIQUITI NETWORKS niniejszym oświadcza, że typ urządzenia radiowego UAP-AC-SHD jest zgodny z dyrektywą 2014/53/UE. Pełny tekst deklaracji zgodności UE jest dostępny pod następującym adresem internetowym: [www.ubnt.com/compliance](http://www.ubnt.com/compliance)

**Português [Portuguese]** O(a) abaixo assinado(a) UBIQUITI NETWORKS declara que o presente tipo de equipamento de rádio UAP-AC-SHD está em conformidade com a Diretiva 2014/53/UE. O texto integral da declaração de conformidade está disponível no seguinte endereço de Internet: [www.ubnt.com/compliance](http://www.ubnt.com/compliance)

**Română [Romanian]** Prin prezenta, UBIQUITI NETWORKS declară că tipul de echipamente radio UAP-AC-SHD este în conformitate cu Directiva 2014/53/UE. Textul integral al declarației UE de conformitate este disponibil la următoarea adresă internet: [www.ubnt.com/compliance](http://www.ubnt.com/compliance)

**Slovenčina [Slovak]** UBIQUITI NETWORKS týmto vyhlasuje, že rádiové zariadenie typu UAP-AC-SHD je v súlade so smernicou 2014/53/EÚ. Úplné EÚ vyhlásenie o zhode je k dispozícii na tejto internetovej adrese: [www.ubnt.com/compliance](http://www.ubnt.com/compliance)

**Slovenščina [Slovenian]** UBIQUITI NETWORKS potrjuje, da je tip radijske opreme UAP-AC-SHD skladen z Direktivo 2014/53/EU. Celotno besedilo izjave EU o skladnosti je na voljo na naslednjem spletnem naslovu: [www.ubnt.com/compliance](http://www.ubnt.com/compliance)

**Español [Spanish]** Por la presente, UBIQUITI NETWORKS declara que el tipo de equipo radioeléctrico UAP-AC-SHD es conforme con la Directiva 2014/53/UE. El texto completo de la declaración UE de conformidad está disponible en la dirección Internet siguiente: [www.ubnt.com/compliance](http://www.ubnt.com/compliance)

**Svenska [Swedish]** Härmed försäkrar UBIQUITI NETWORKS att denna typ av radioutrustning UAP-AC-SHD överensstämmer med direktiv 2014/53/EU. Den fullständiga texten till EU-försäkran om överensstämmelse finns på följande webbadress: [www.ubnt.com/compliance](http://www.ubnt.com/compliance)



## Online Resources

Support [help.ubnt.com](http://help.ubnt.com)

Community [community.ubnt.com](http://community.ubnt.com)

Downloads [downloads.ubnt.com](http://downloads.ubnt.com)

Ubiquiti Networks, Inc.  
685 Third Avenue, 27th Floor  
New York, NY 10017  
USA



[www.ubnt.com](http://www.ubnt.com)

©2016-2017 Ubiquiti Networks, Inc. All rights reserved. Ubiquiti, Ubiquiti Networks, the Ubiquiti U logo, the Ubiquiti beam logo, TOUGHCable, and UniFi are trademarks or registered trademarks of Ubiquiti Networks, Inc. in the United States and in other countries. Apple and the Apple logo are trademarks of Apple Inc., registered in the U.S. and other countries. App Store is a service mark of Apple Inc. Android, Google, Google Play, the Google Play logo and other marks are trademarks of Google Inc. All other trademarks are the property of their respective owners.

JLAJ090617